



802378

04/11

Montage- und Serviceanleitung
 Instructions de montage et d'entretien
 Istruzioni di montaggio e di assistenza
 Instrucciones de montaje y servicio
 Installation and service instructions

Zubehör
 Accessoires
 Accessori
 Accesorios
 Accessories

KWC AVA

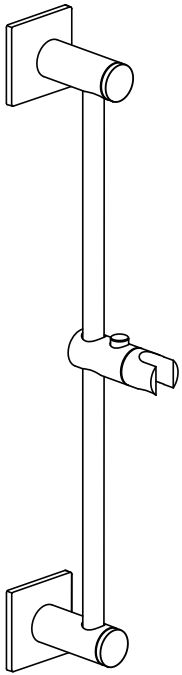

26.190.502.000
L1100

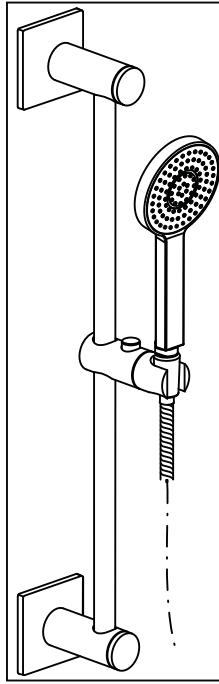

26.190.572.000
L1100

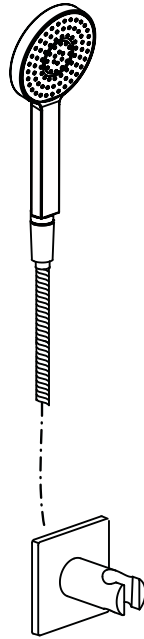

26.190.480.000 L1250
26.190.470.000 L1800

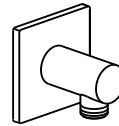

26.191.610.000
26.191.610.127

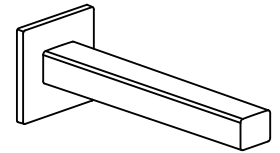

26.191.073.000
26.191.073.127

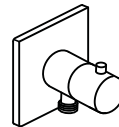

26.191.620.000
Nur für Österreich

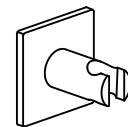

Z.536.168.000
Z.536.168.127

Schweiz, Suisse:
 KWC AG
 Hauptstrasse 57
 5726 Unterkulm

Tel.: 062 768 68 68
 Fax: 062 768 61 62

Deutschland:
 KWC Deutschland GmbH
 Sigmaringer Strasse 107
 70567 Stuttgart

Tel: 0711 49 08 39-0
 Fax: 0711 49 08 39-30

Italia:
 KWC Italia Srl
 Via M. Gaetana Agnesi 37
 I-37014 Castelnuovo del Garda (VR)

Tel. 045 757 06 58
 Fax 045 757 04 67

France:
 Hansa France
 Rue Ettoré Bugatti
 67038 Strasbourg-Cedex2

Tél: 03 88 78 88 08
 Fax: 03 88 76 55 32

Oesterreich:
 Hansa Austria GmbH
 Rottfeld 7
 5020 Salzburg

Tel: 0662 433 100
 Fax: 0662 433 100 20

USA:
 KWC AMERICA INC.
 1770 Corporate Drive #580 0
 US - Norcross, Georgia 30093

Phone 678 334 21 21
 Fax 678 334 21 28



Recyclingpapier auf 100% Altpapierbasis.
 Papier de recyclage sur 100% bases de vieux papier.
 Riciclaggio della carta sulla base della carta straccia di 100%.
 Reciclaje del documento sobre base del papel usado del 100%.
 Recycling paper on 100% waste paper basis.

Ersatzteile
 Pièces de rechange
 Pezzi di ricambio
 Repuestos
 Spare parts

AUT

26.191.620.000

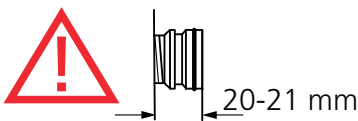
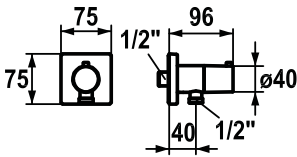

Z.536.264.000

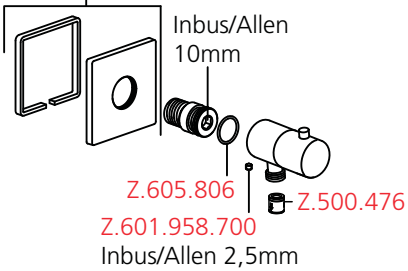

CH/EU

26.191.610.000

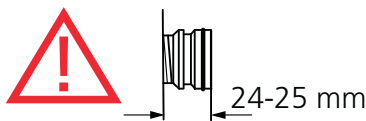
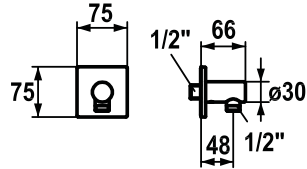

Z.536.264.000

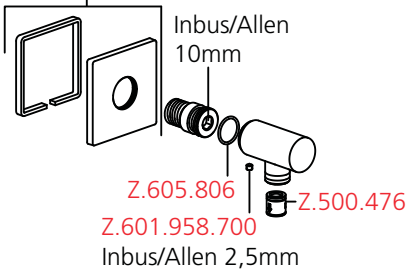

USA/CAN

**26.191.610.000
 26.191.610.127**

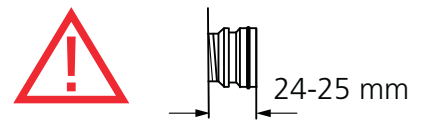
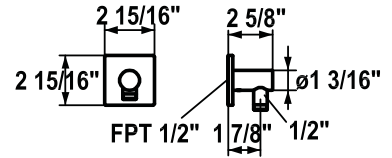

Z.536.264.000
 Z.536.264.127

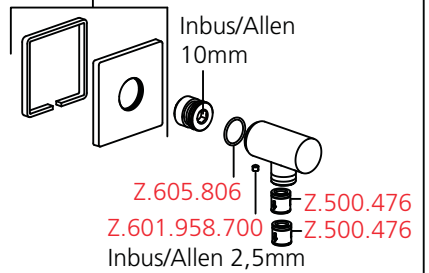

**26.191.073.000
 26.191.073.127**

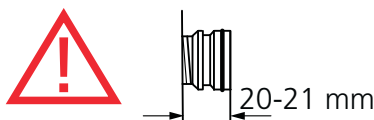
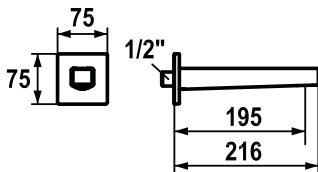

Z.536.266.000

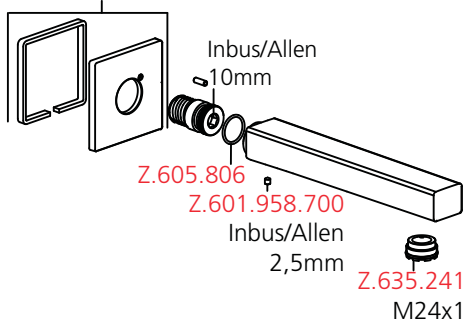

M24x1
 Z.635.231

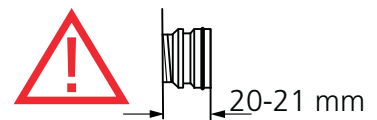
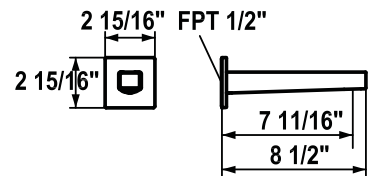
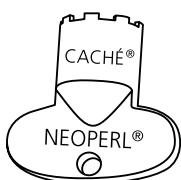

Z.536.266.000
 Z.536.266.127

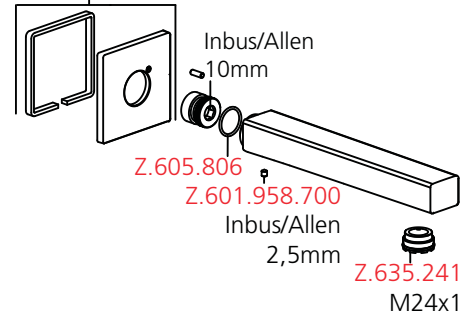

Ersatzteile
 Pièces de rechange
 Pezzi di ricambio
 Repuestos
 Spare parts

CH/EU

USA/CAN

Z.536.222.000

Z.536.168.000

Z.536.168.000
 Z.536.168.127

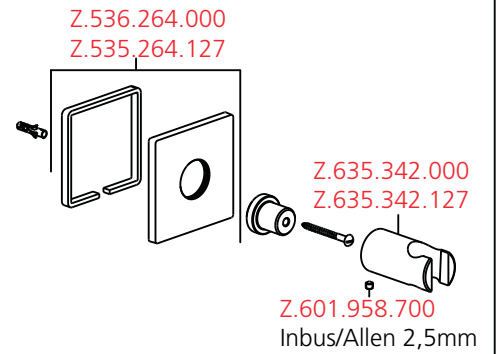
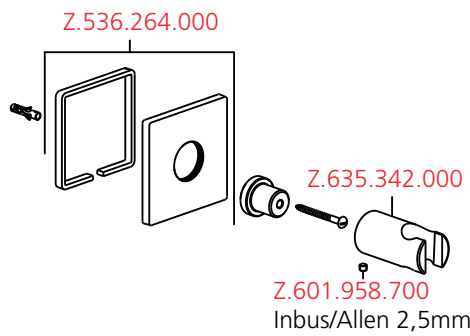
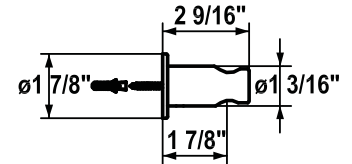
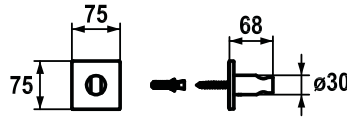
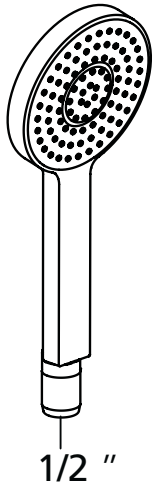

Montage und Ersatzteile
 Montage et pièces de rechange
 Montaggio e pezzi di ricambio
 Montaje e repuestos
 Assembly and spare parts

26.190.502.000

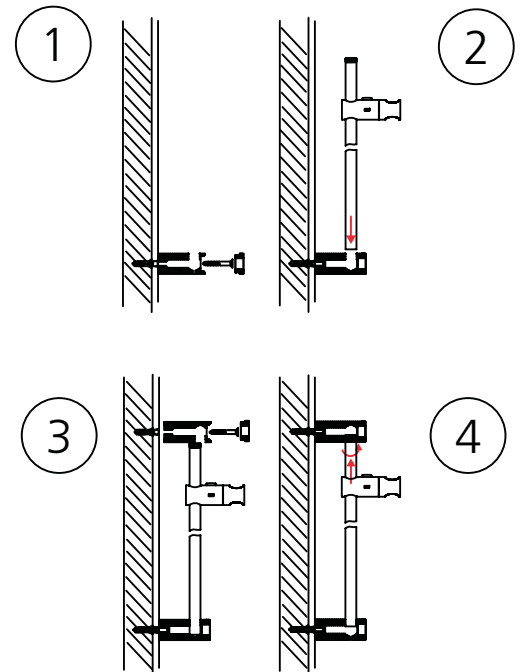
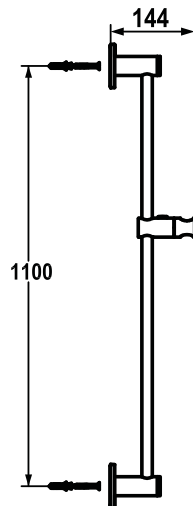
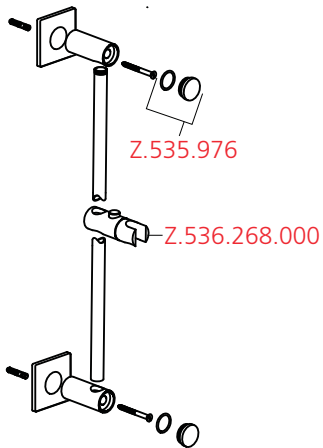

Pflegeanleitung für Armaturen und Zubehör

Instruction pour la maintenance des robinets et des accessoires

Istruzioni per la manutenzione di rubinetti e accessori

Instrucciones para el cuidado de griferias y accesorios

Maintenance / Cleaning instructions for faucets and accessories

Grundsätzliche Reinigungshinweise:

- Beim Reinigen muss die Oberfläche der Armatur kalt sein (Wärme beschleunigt die Zerstörung der Oberfläche)!
- Reinigungshinweise der Reinigungsmittelhersteller beachten!

Die Pflege:

- Armatur täglich mit weichem Lappen trocken reiben!
- Scheuernde Reinigungsmittel und Putzschwämme unbedingt vermeiden!

Die Reinigung:

- Schmutz- oder Kalkflecken auf der Armaturenoberfläche nur mit mildem Reinigungsmittel entfernen!
- Sofort nach dem Reinigen alle Reinigungsmittelrückstände mit kaltem Wasser wegspülen!
- Mit weichem Lappen trocken reiben.

Instructions principales pour le nettoyage:

- Durant le nettoyage, la surface du robinet doit être froide (la chaleur accélère l'usure de la surface)!
- Nous vous prions de faire attention aux indications mentionnées sur les nettoyages!
- Assurez vous que les produits ne contiennent pas d'acides ou des substances corrosives.

L'entretien:

- Le robinet doit être nettoyé chaque jour avec un chiffon mou.
- Evitez absolument l'usage des brillants pour métaux, éponges abrasives ou produits similaires!

Le nettoyage:

- Enlevez salissures et dépôts calcaires de la surface du robinet seulement avec des produits qui ne sont pas agressifs!
- Immédiatement après le nettoyage, rincer bien les résidus des détergents avec de l'eau froid!
- Sécher avec un chiffon mou.

Principali istruzioni per la pulizia:

- Durante la pulizia, la superficie del rubinetto deve essere fredda (il calore accelera il logorio della superficie)!
- Fare attenzione alle indicazioni riportate sui prodotti per la pulizia!
- Accertarsi che non contengano acidi o sostanze corrosive.

La manutenzione:

- Il rubinetto deve essere asciugato quotidianamente con un panno morbido.
- Evitare assolutamente paglietta, spugne abrasive o similari!

La pulizia:

- Togliere sporco e calcare dalla superficie del rubinetto solo con detersivi non aggressivi!
- Subito dopo la pulizia, sciacquare bene i residui di detersivo con acqua fredda!
- Asciugare con un panno morbido.

Avisos básicos de limpieza:

- Cuando se procede a limpiar la griferia, su superficie debe estar fría (el calor acelera la destrucción de la superficie)!
- Respetar los avisos de limpieza del fabricante del detergente!

Cuidado:

- Secar la griferia frotando diariamente con un paño blando!
- Evite, imprescindiblemente, detergentes y esponjas de limpieza raspantes!

Limpieza:

- Quitar las manchas de suciedad o cal en la superficie de la griferia sólo con un detergente poco agresivo!
- Inmediatamente después de la limpieza eliminar, enjuagando con agua fría, todos los residuos del detergente!
- Secar frotando con un paño blando.

General Cleaning Instructions:

- Faucet surface must be of room temperature before cleaning (elevated temperature increases damage of the surface).
- Cleaning instructions of the detergent manufacturer must be followed.

Maintenance:

- Rub the faucet daily dry with a soft cloth.
- Never use corrosive cleaners or cleaning pads.

Cleaning:

- Dirt or calcareous deposits on the faucet surface must be removed with soft detergent or with soap water!
- Rinse well with water immediately after cleaning (make sure that no detergent remains on the surface)
- Dry with soft cloth.



- D Schäden, die infolge unsachgemässer Behandlung, natürlicher Abnutzung oder zu grosser Inanspruchnahme entstanden sind, sind von unseren Garantieleistungen ausgeschlossen!
- F Ces dommages survenus en raison d'un traitement inadéquat, des signes d'usure traitement inadéquat, naturels ou du grand utilisation, sont exclus de notre garantie.
- I Danni ai rubinetti, conseguenti da un trattamento non appropriato, sono esclusi dalla nostra garanzia!
- Sp Daños, debidos a un tratamiento inadecuado, son excluidos de la nuestra garantía.
- E Damages on the faucet resulting from incorrect handling are excluded from the manufacturers warranty!